

Altherma 3 Low Temperature Twin Fan Integrated

Inside the Machine



What is the machine doing



Power Up Settings



Error on Setup



Customer Settings



Hot Water + Heating on and off



Set Schedules



End User Settings



Programming a USB



Loading settings from a USB



Piping Connections

- A) Space Heating out - 1"
- B) Space Heating in - 1"
- C) Domestic Hot Water out - 3/4"
- D) Cold Water Supply - 3/4"
- E) Water Connection out - 1"
- F) Water Connection in - 1"

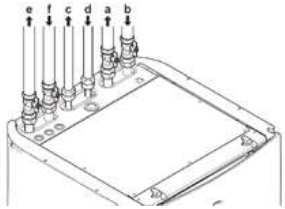

| Unit | Delta T | 1" Copper | 1" 1/4 Copper |
|----------|---------|---------------------|---------------------|
| | | Max Pipe Length (m) | Max Pipe Length (m) |
| EPGA11DV | 5 | 62 | 210 |
| | 8 | 189 | 636 |
| EPGA14DV | 5 | 26 | 89 |
| | 8 | 110 | 371 |
| EPGA16DV | 5 | 12 | 40 |
| | 8 | 82 | 278 |

| LEGEND: | |
|---------|---|
| OU | Outdoor Unit EPGA11-16DV |
| IU | Indoor Unit EAVH016S(18/23)D6V/D9W |
| IV | Isolation Valve delivered with unit |
| FK | Filling Kit field supply, according to local regulations |
| STR | Strainer field supply |
| EV | Expansion Vessel field supply |
| CW | Water Inlet Safety Group field supply, according to local regulations |
| TMV | Thermostatic Valve field supply |
| BPV | ByPass Valve delivered with unit |
| UFH | Underfloor Heating field supply |
| UH | Manifold field supply |
| AFV | Anti Freeze Valve ordered separately |

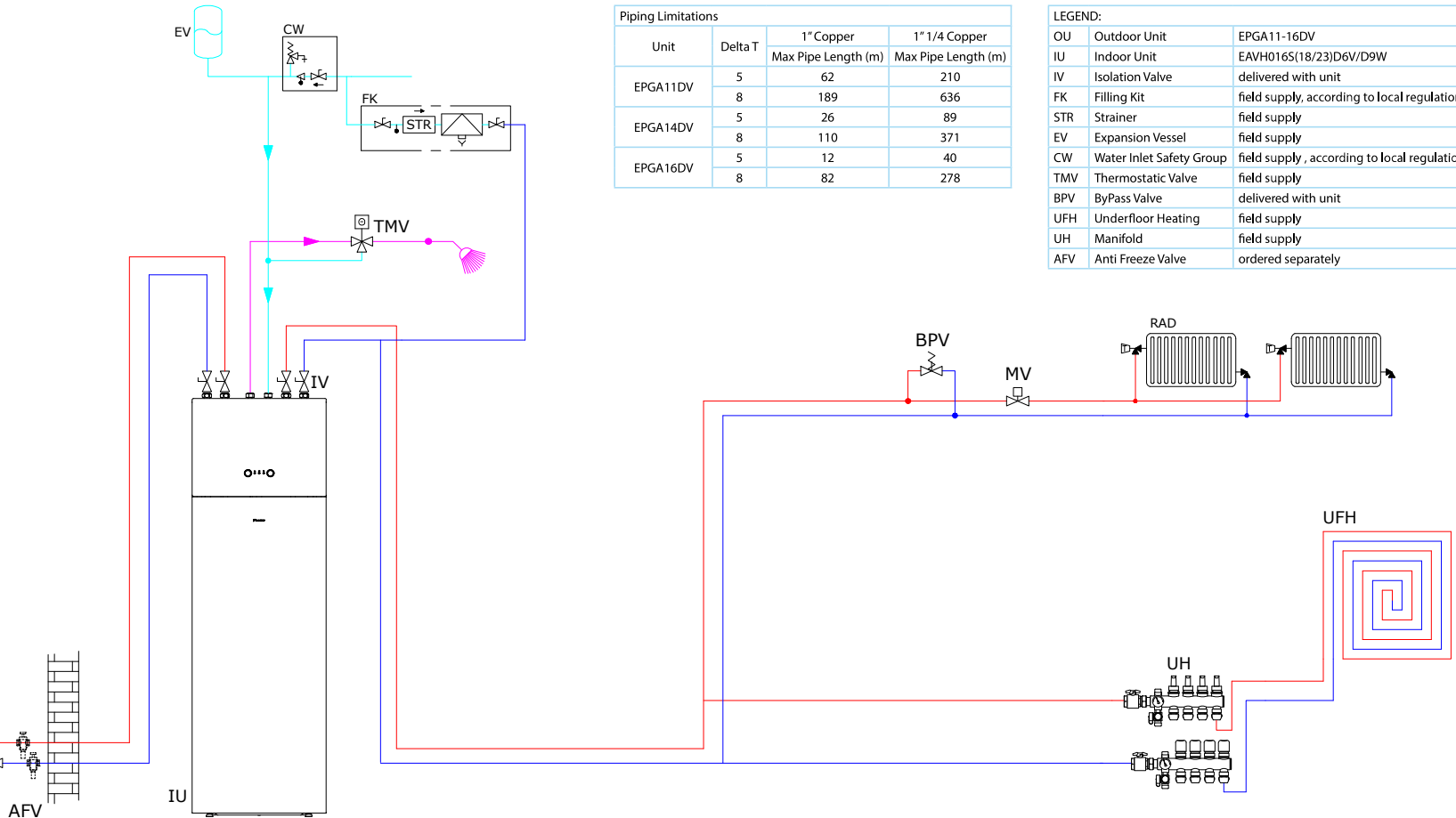
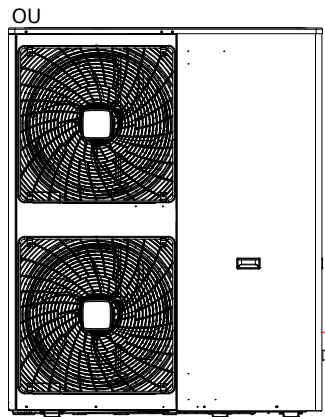

Outdoor Mounting

Wall Mounted:

The unit should be installed on cantilever arms (field supply) with drip tray fitted (available via Daikin) and condensate pipe fitted to storm drain.

Floor Standing:

The unit should be installed on 3 rubber mounts/flexi feet (supplied via Daikin). The drainage can also be achieved by the means of an eco-drain or drain gully underneath the unit connected to storm drain.

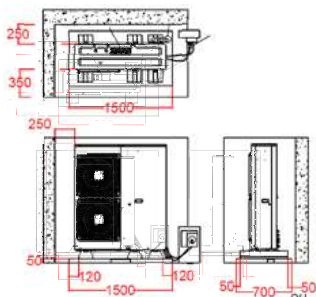

DAIKIN Precommissioning Steps

1. Plinth sized correctly as shown with condensate run off
2. Duct sealed and dry
3. Power to Indoor and Outdoor unit
4. Power to Back-Up Heater
5. External control wired
6. System filled and vented
7. Bypass valve fitted on farthest loop from heat pump. Ensure min. flow rate as per manuals

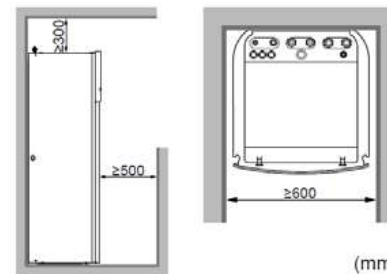

Indoor Mounting

All components are accessible via the front panels.

There is a condensate pipe pre fitted which needs to be drained appropriately. This can be routed to the left or right hand side of the unit.

Note: indoor unit dimensions are 600mm wide x 625mm deep. The 180ltr unit is 1650mm high and the 230ltr is 1850mm. The 180ltr unit is 131kg and the 230ltr is 139kg.

Altherma 3 Low Temperature Twin Fan Integrated



LEGEND:

| | | |
|-----|--------------------|--|
| OU | Outdoor Unit | EPGA11-16DV |
| IU | Indoor Unit | EAVH11-16S(18/23)D6V/D9W |
| UFH | UFH Wiring Centre | field supply |
| MV | Motorized Valve | field supply |
| 1 | Outdoor to Mains | 6sq x 3 core power supply with isolation switch and 32Amp fuse |
| 2 | Indoor to Mains | 4sq x 3 core power supply with 25Amp fuse |
| 3 | Outdoor to Indoor | 2.5sq x 4 Core communication |
| 4 | Indoor heat demand | 0.75 X 2 Core Volt free contact |

Outdoor Unit Switchbox location

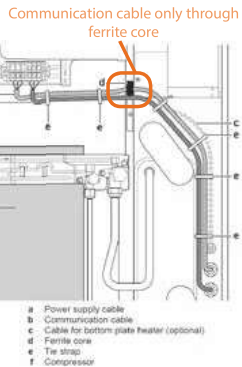
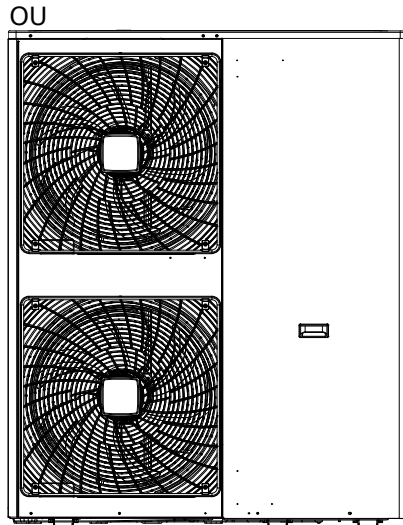
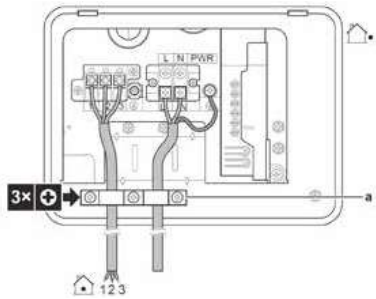

32 Amp Fuse For Outdoor

25 Amp Fuse For Indoor

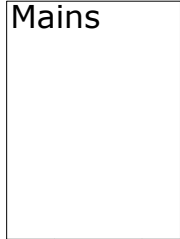

Back-Up Heater Wiring



4sq 3 core IU - Mains (2)
Pre - Wired

Please allow 30cm slack on these connections to ensure panel can be removed for access

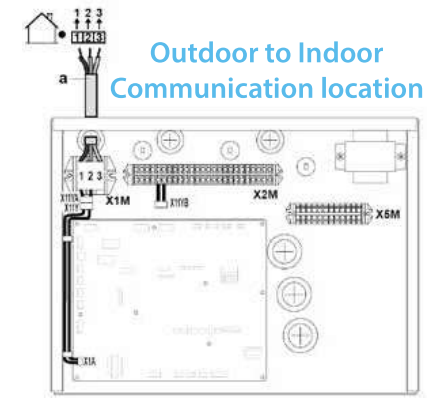

Outdoor to Indoor Communication location

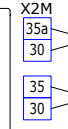
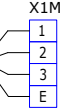

VFC for Heat Demand (4)

30 & 35 Main Zone

UFH - Wiring Centre

30 & 35a Additional Zone

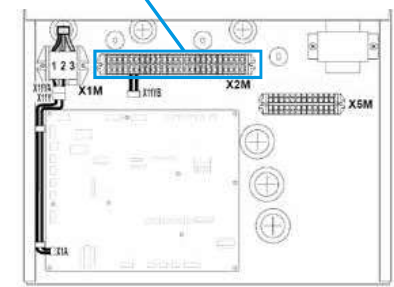

Indoor Unit X2M location

IU

2.5sq 4 core OU - IU - (3)

6sq 3 core OU - Mains (1)